

1

2

3

4

5

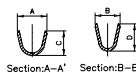
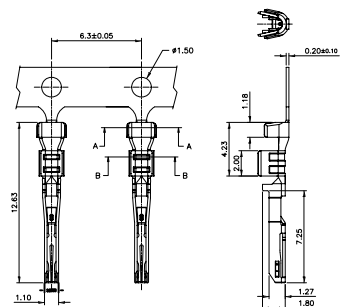

HST25X-XXXX

Part No	Wire Apply	A	B	C	D
HST25X-2022	20-22AWG	2.33Ref.	1.97Ref.	1.94	2.14
HST25X-2426	24-26AWG	2.12Ref.	1.39Ref.	2.00	1.45

Specifications:
 Current Rating:14.0A AC/DC
 Voltage Rating:400V AC/DC
 Contact Resistance:10m ohm. Max.
 Insulation Resistance:1000M ohm. Min.
 Withstanding Voltage:1.800V AC/Minute
 Operating Temperature Range:-40°C~+105°C
 Material and Finish
 Insulator:Nylon 4T UL94V-0
 Color:Black
 Contact:Phosphor Bronze
 Plating:Gold Plated
 Reommended Insulator

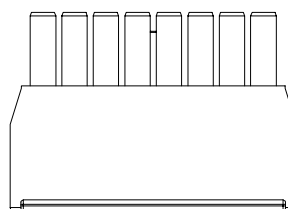
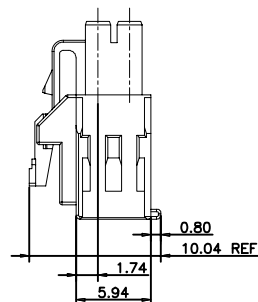
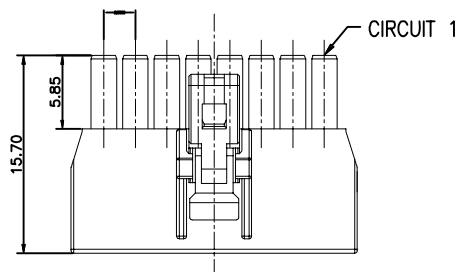
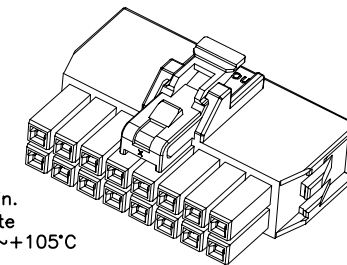

How To Order
 HS25-XX-LK-XX

BK:Black
 WH:White
 With Lock
 No. Of Positions

Dimension:

Pos.	Dimension:
04	7.70
06	10.20
08	12.70
10	15.20
12	17.70
14	20.20
16	22.70

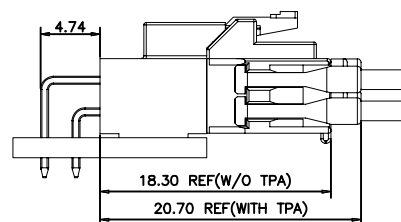
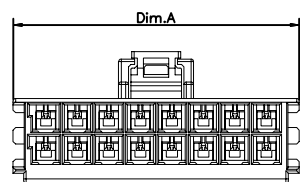

RoHS Compliant

F				DRAWN:	GENERAL TOLERANCE:		DESCRIPTION: 2.5mm Female Housing With Lock	SIZE A4
E				Ken	.X=±0.20 .XX=±0.15			
D				CHECKED:	UNIT: MM			
C				Lily Chou	SCALE: 1:1			
B				APPROVAL:	SHEET: 1 / 2	PART NO:	HS25-XX-LK-XX	
A	04-Nov-2019	(PC0001)	Ken	Chao Peng	PROJECTION:			
REV	DATE	FILE	BY					