

Circuits	Dim.A±0.25	Dim.B±0.15	Dim.C±0.25	Dim.D±0.15	Dim.E±0.25
2	7.62	—	13.97	6.35	4.30
3	7.62	—	20.32	12.70	4.30
4	7.62	—	26.67	19.05	4.30
5	7.62	—	33.02	25.40	4.30
6	20.32	12.70	13.97	6.35	4.30
7	7.62	—	45.72	38.10	4.30
8	7.62	—	52.07	44.45	4.30
9	20.32	12.70	20.32	12.70	4.30
10	7.62	—	64.77	57.15	4.30
12	20.32	12.70	26.67	19.05	4.30

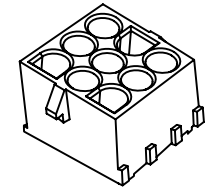

Specifications:

Current Rating:13.0 Amps
 Voltage Rating:600V AC/DC
 Contact Resistance:20m Ohm Max
 Insulator Resistance:1000M Ohm Min
 Withstanding Voltage: 5000V AC/Minute
 Operating Temperature Range:-55°C To +105°C
 Materials and Finish:
 Insulator:Nylon 66 (UL94V-2)
 Contact:Phosphor Bronze
 Plating:Tin Plated

How to Order

WFPV635-XX

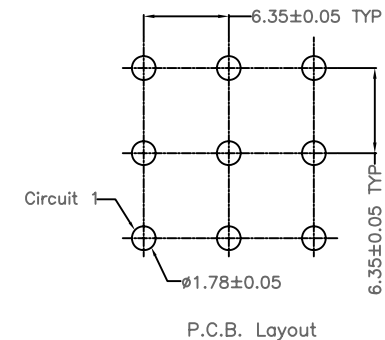
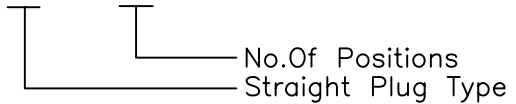

RoHS Compliant

F				DRAWN:	GENERAL TOLERANCE:		DESCRIPTION: 6.35mm Power Wafer Straight Type	SIZE A4
E			Ken	.X=±0.20 .XX=±0.15				
D			CHECKED:	UNIT: MM				
C			Lily Chou	SCALE: 1:1				
B			APPROVAL:	SHEET: 1 / 2	PART NO:	WFPV635-XX		
A	01-SEP-2013	(PC0001)	Ken	Chao Peng	PROJECTION:			
REV	DATE	FILE	BY					

1

2

3

4

5

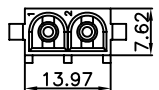

13.97



7.62

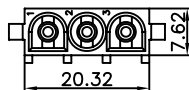

20.32



7.62

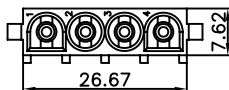

26.67



7.62

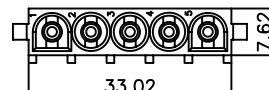

33.02



7.62

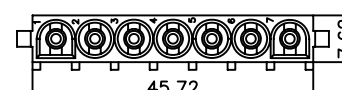

45.72



7.62

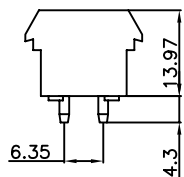

13.97

6.35



4.3

WFPV635-02

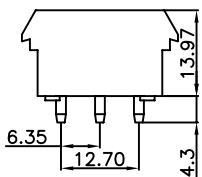

13.97

6.35

12.70



4.3

WFPV635-03

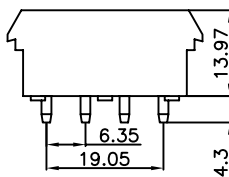

13.97

6.35

19.05



4.3

WFPV635-04

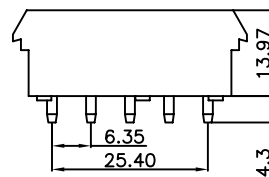

13.97

6.35

25.40



4.3

WFPV635-05

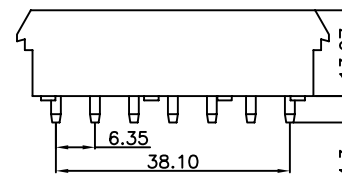

13.97

6.35

38.10



4.3

WFPV635-07

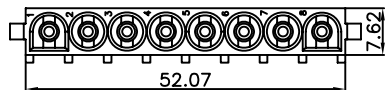

52.07



7.62

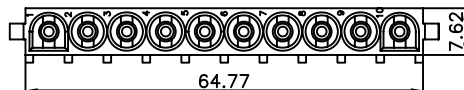

64.77



7.62

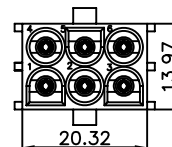

20.32



13.97

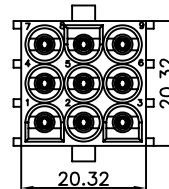

20.32



20.32

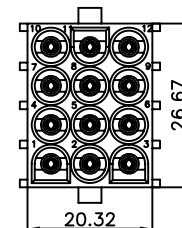

20.32



26.67

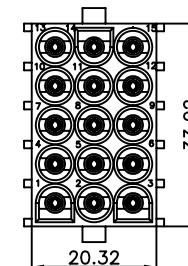

20.32



33.02

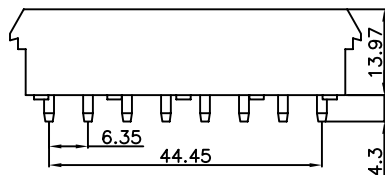

13.97

6.35

44.45



4.3

WFPV635-08

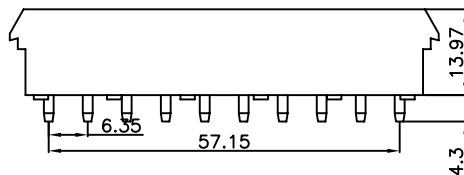

13.97

6.35

57.15



4.3

WFPV635-10

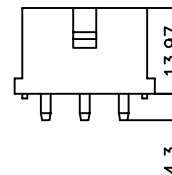

13.97



4.3

WFPV635-06

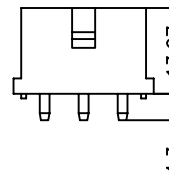

13.97



4.3

WFPV635-09

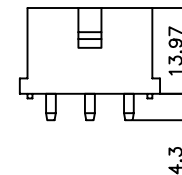

13.97



4.3

WFPV635-12

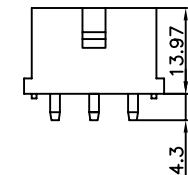

13.97



4.3

WFPV635-15

RoHS Compliant

F				DRAWN:	GENERAL TOLERANCE:		DESCRIPTION: 6.35mm Power Wafer Straight Type	SIZE A4
E				Ken	.X=±0.20			
D				CHECKED:	.XX=±0.15			
C				Lily Chou	UNIT: MM			
B				APPROVAL:	SCALE: 1:1	DESCRIPTION:	SIZE	
A	01-SEP-2013	(PC0001)	Ken	Chao Peng	SHEET: 2 / 2	PART NO:		
REV	DATE	FILE	BY		PROJECTION:	WFPV635-XX		

DRAWN:
Ken

CHECKED:
Lily Chou

APPROVAL:
Chao Peng

GENERAL TOLERANCE:
.X=±0.20
.XX=±0.15

UNIT: MM

SCALE: 1:1

SHEET: 2 / 2

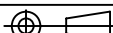
PROJECTION: 

DESCRIPTION:
6.35mm Power Wafer Straight Type

PART NO:
WFPV635-XX

SIZE
A4